

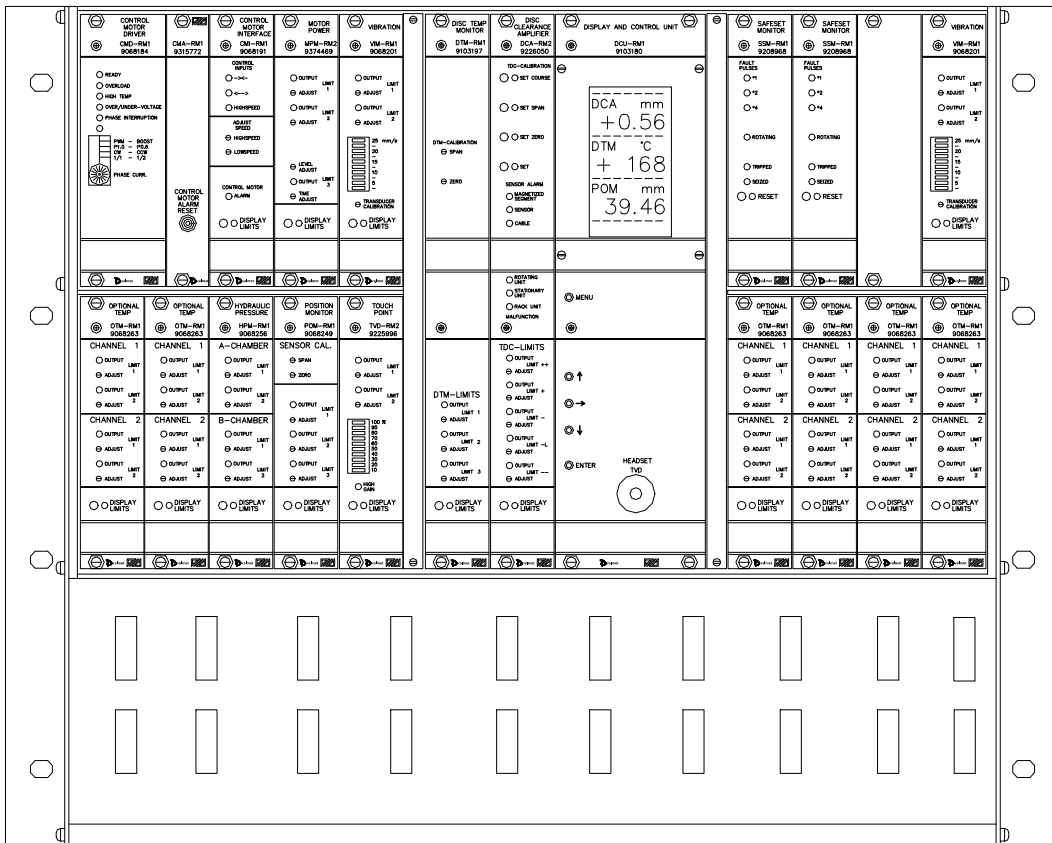

CALIBRATION

RMS-DD1



CALIBRATION MANUAL
FOR THE RMS-DD1 SYSTEM

CONTENTS

- 1. CALIBRATION
 - 1.1. TDC-XXX TDC-SENSOR
 - 1.2. POT-50 ROTOR POSITION SENSOR
 - 1.3. DTM-RM1 DISC TEMPERATURE UNIT
- 2. ADJUSTMENT
 - 2.1. CMI-RM1 CONTROL MOTOR INTERFACE
 - 2.2. MPM-RM2 MOTOR POWER MONITOR
 - 2.3. VIM-RM1 VIBRATION MONITOR
 - 2.4. OTM-RM1 OPTIONAL TEMP MONITOR
 - 2.5. HPM-RM1 HYDRAULIC PRESSURE MONITOR
 - 2.6. POM-RM1 POSITION MONITOR
 - 2.7. TVD-RM1 TOUCHPOINT VIBRATION DETECTOR
 - 2.8. DTM-RM1 DISC TEMPERATURE MONITOR
 - 2.9. DCA-RM1 DISC CLEARANCE AMPLIFIER

1. CALIBRATION

1.1. CALIBRATION OF TDC-SENSOR

1.1.1 GENERAL

The TDC-sensor should always be calibrated after a segment change and after changing to a new sensor. The sensor is calibrated with the machine unloaded and at a stable temperature. This means that the machine should either be cold, i.e. without flushing steam, or fully warmed up with flushing steam. The later is recommended.

Since both flat and conical segments are used, extra attention must be paid to the touch point during the calibration. This is due to a difference in the contact point between unloaded and loaded refiners. Tests have shown that the difference is 0.40 mm for flat zone refiners.

The adjustment is carried out on the DCA-RM1 unit through switches in the front of the panel.

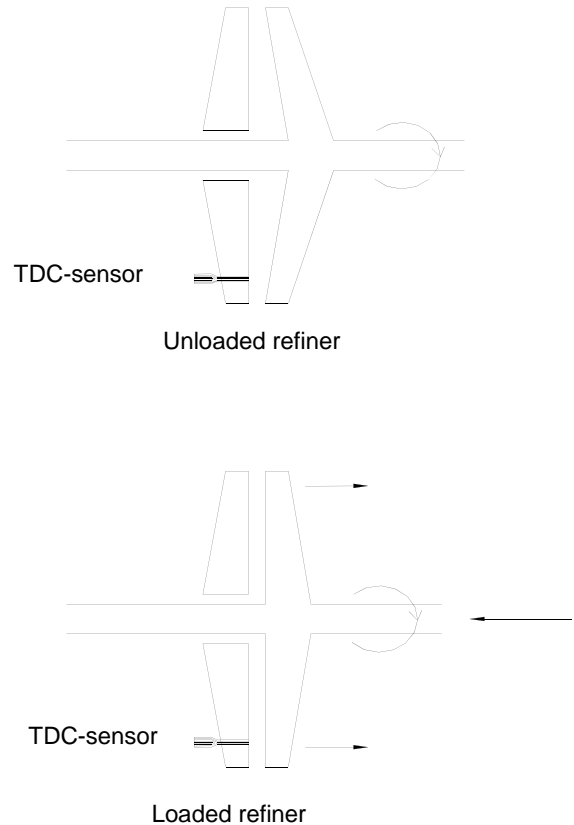

1.1.2 PRE-CALIBRATION

- Check that the TDC-sensor is mounted in line with the refining segments, and that it is fully tightened.
- When the "TOUCHPOINT-POSITION" key-switch is set to "ON" position, the info-display of the PDU unit will indicate "TVD LIMIT XX %". When the TVD-level has passed the limit during the touch point procedure, the display will instead indicate a relative POM-value (this is related to the rotor position value at the touch point position).
- The reading will go out when the "TOUCH-POSITION" key-switch is set to the "OFF" position.

1.1.3 COARSE CALIBRATION

- This is only needed when a new sensor has been mounted. If the DCA-unit is re-calibrated, continue with the zero calibration.
- Turn the key-switch for TDC calibration to the "COARSE" position.
- Move the plates until the plate-gap is larger than 8 mm.
- Press the "SET" switch. The DCA-unit is set to a 3.00 value.

1.1.4 ZERO CALIBRATION

- Turn the key-switch for TDC calibration to the "ZERO" position.
- Run carefully the grinding discs together until the touch point is detected.
The relative POM is preset to -0.10.
- Run the discs apart until the relative POM reads 0.00.
- Press the "SET" switch. The DCA-unit is set to 0.50 mm.

1.1.5 SPAN ADJUSTMENT

- Turn the key-switch for TDC calibration to the "SPAN" position.
- Run the discs 1.00 mm further apart until the relative POM reads +1.00.
- Press the "SET" switch. The DCA-unit is now set to 1.50 mm.

1.1.6 CALIBRATION COMPLETED

- Turn the key-switch for TDC calibration to the "COMPLETE" position.
- Set the "TOUCH-POSITION" key-switch to the "OFF" position.
- Press the "SET" switch (the indicator "TDC NOT CALIBRATED" will go off).
- Turn the key-switch for TDC calibration to the "OFF" position.

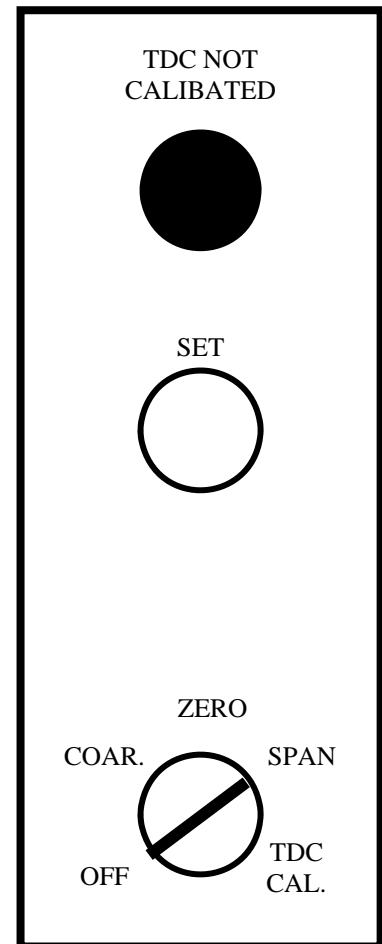

1.2. CALIBRATION OF THE OF ROTOR POSITION SENSORS

The rotor position sensor has to be recalibrated when it is installed or when the monitor unit, POM-RM1 has been replaced

- Remove the sensor from the holder.
- Push the "Display Limits" on the POM-RM1 unit. The POM-value can then be read from the DCU-RM1 unit or from the PDU-RM1 unit.
- Push the measuring rod of the sensor to the fully inner position.
- Adjust the potentiometer "ZERO" on the POM-RM1 unit until the monitor reads 0.00 mm.
- Release the measuring rod so it is fully expanded.
- Adjust the potentiometer "SPAN" until the monitor reads 50.00 mm.
- Set the rotor position to its absolute adjustment position according to the refiner instruction manual. Mount the sensor to the holder on the refiner and adjust the sensor until the monitor displays the value according to the refiner instruction manual. Fix the sensor in this position.
- The sensor is mechanically limited to 50 mm stroke length. It is essential that the refiner's stroke length is within that of the sensor. If the sensor is forced beyond the inner endpoint, it will be destroyed.

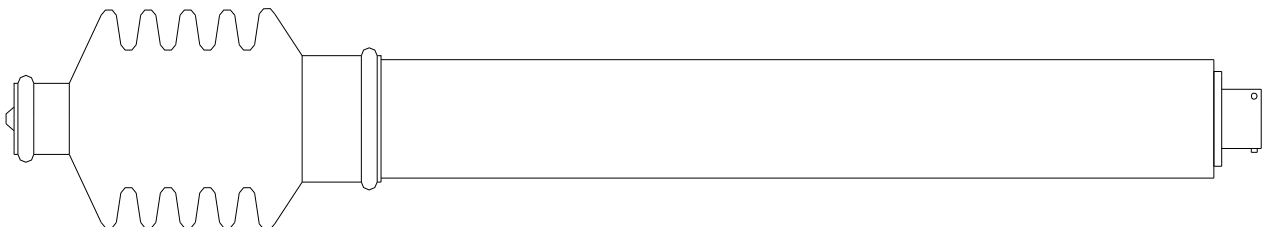
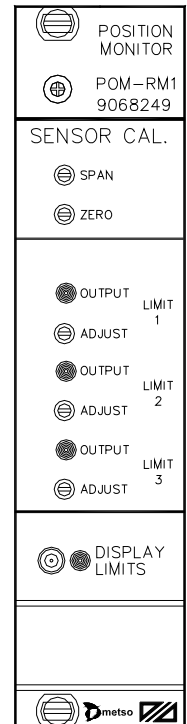

1.3. CALIBRATION OF THE DTM-UNIT

The DTM-RM1 is adjusted together with the DCA-RM2, amplifier unit.

A DIP-switch on the DCA-unit must be set to enable nominal levels to the DTM-unit. The switches on the front of the DCA-unit do selection between zero and span levels. The DIP-switch is located on the lower side of the unit and is easy accessible from under. Do not unplug the unit from the rack.

- DCA-RM2:
Set the DIP-switch SW9/4 to the on position.
Press the ZERO-switch (the zero led light's up).
- DTM-RM1:
Adjust the potentiometer "ZERO" until a "000" reading.
- DCA-RM2:
Press the SPAN-switch (the span led light's up).
- DTM-RM1:
Adjust the potentiometer "SPAN" until a "225" reading.
- DCA-RM2:
Set the DIP-switch SW9/4 to the off position.

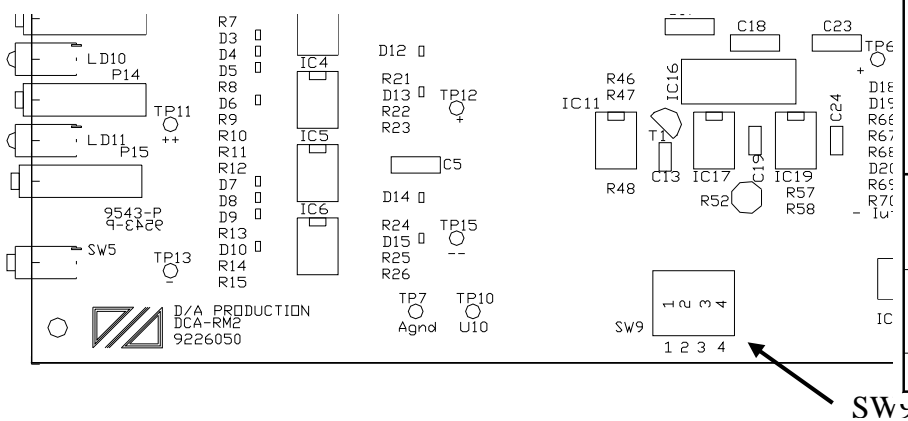
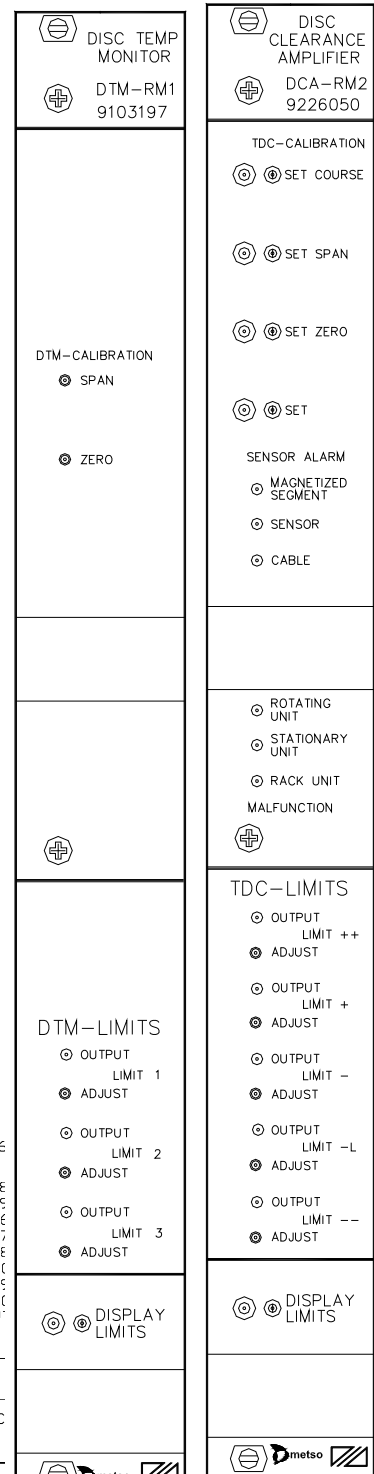

2. ADJUSTMENT

General

Select the chosen RMS-unit to the DCU-display by the push-button "DISPLAY LIMITS" on the RMS-unit. The display is activated for about 2 minutes after the "DISPLAY LIMITS" buttons was activated, and will then automatically be turned off.

If the "→" push-button on the DCU-RM1 is activated, the auto-turnoff is disabled. This is indicated by a "*" in the lower right corner of the display.

The auto turnoff is reactivated if the "DISPLAY LIMITS" is pressed again.

Press the "MENU" button to return to the normal readout.

2.1. ADJUSTMENT OF THE CMI-RM1 UNIT

Push "DISPLAY LIMITS" on the CMI-RM1 unit and the DCU-display will indicate the limit values for high speed and low speed.

2.1.1 HIGH SPEED

Read the high-speed value and adjust the high-speed potentiometer. Values can be adjusted between 50 and 150%. If 100% is chosen, the speed of the axial movement will be 0.25 mm/s. If the stepping motor is working while adjusting, the change will be affected first upon the next activation.

2.1.2 LOW SPEED

Read the low-speed value and adjust the low-speed potentiometer. Values can be adjusted between 50 and 150%. If 100% is chosen, the speed of the axial movement will be 0.05 mm/s. If the stepping motor is working while adjusting, the change will be affected first upon the next activation.

DCA	2.23
DTM	168
POM	39.46
CMI	%
H-sp.	100
L-sp.	100
DIFF	+0
ENABLED	

2.2. ADJUSTMENT OF THE MPM-RM2 UNIT

Push "DISPLAY LIMITS" on the MPM-RM2 unit and the DCU-display will indicate the measured value and the limit values.

All values are related to the programmed nominal main motor power (see the programmers manual, PRO-DD1).

2.2.1 MEASURED VALUE

The measured value is indicated by "MPM".

2.2.2 ADJUST LIMIT 1

Read the value at "Low" and adjust the potentiometer "LIMIT 1" to desired value. Values can be adjusted between 0 and 100% of the nominal main motor power.

2.2.3 ADJUST LIMIT 2

Read the value at "LoLow" and adjust the potentiometer "LIMIT 2" to desired value. Values can be adjusted between 0 and the nominal main motor power.

2.2.4 ADJUST LIMIT 3, LEVEL

Read the value at "Level" and adjust the potentiometer "LEVEL ADJUST" to the desired value. Values can be adjusted between 0 and 100% of the nominal main motor power.

2.2.5 ADJUST LIMIT 4, TIME

Read the value at "Time" and adjust the potentiometer "TIME ADJUST" to desired value. Values can be adjusted between 0 and 10.0 s.

DCA	2.23
DTM	168
POM	39.46
MPM	MW
MPM	7.50
Low	2.1
Lowlow	1.8
Level	1.0
Time	3.0

2.3. ADJUSTMENT OF THE VIM-RM1 UNIT

Push "DISPLAY LIMITS" on the VIM-RM1 unit and the DCU-display will indicate the measured value and the limit values.

2.3.1 MEASURED VALUE

The measured value is indicated by "VIM".

2.3.2 ADJUST LIMIT 1

Read the value at "Lm 1" and adjust the potentiometer "LIMIT 1" to desired value. Values can be adjusted between 0 and 25 mm/s.

2.3.3 ADJUST LIMIT 2

Read the value at "Lm 2" and adjust the potentiometer "LIMIT 2" to desired value. Values can be adjusted between 0 and 25 mm/s.

DCA	2.23
DTM	168
POM	39.46
VIM	mm/s
MPM	3.5
Lm 1	12.0
Lm 2	10.0

2.4. ADJUSTMENT OF THE OTM-RM1 UNITS

Up to 6 units can be used in the system. The DCU-unit indicates the selected unit by

"OTM-1" thru "OTM-6". OTM-1 and OTM-2 is on the left hand side of the rack while OTM-3 thru OTM-6 is on the right hand side.

Push "DISPLAY LIMITS" on the chosen OTM-RM1 unit and the DCU-display will indicate the measured values and the limit values. The values are related to the nominal temperature setting, 100 or 200 °C.

2.4.1 MEASURED VALUES

The measured value for channel 1 is indicated by "Ch 1"

The measured value for channel 2 is indicated by "Ch 2"

2.4.2 ADJUST CHANNEL-1 LIMIT 1

Read the value at "Ch 1, Lm 1" and adjust the potentiometer "CHANNEL 1, LIMIT 1" to desired value. Values can be adjusted between 0 and 100% of nominal temperature.

2.4.3 ADJUST CHANNEL-1 LIMIT 2

Read the value at "Ch 1, Lm 2" and adjust the potentiometer "CHANNEL 1, LIMIT 2" to desired value. Values can be adjusted between 0 and 100% of nominal temperature.

2.4.4 ADJUST CHANNEL-2 LIMIT 1

Read the value at "Ch 2, Lm 1" and adjust the potentiometer "CHANNEL 2, LIMIT 1" to desired value. Values can be adjusted between 0 and 100% of nominal temperature.

2.4.5 ADJUST CHANNEL-2 LIMIT 2

Read the value at "Ch 2, Lm 2" and adjust the potentiometer "CHANNEL 2, LIMIT 2" to desired value. Values can be adjusted between 0 and 100% of nominal temperature.

DCA	2.23
DTM	168
POM	39.46
OTM-1 (100)	°C
Ch 1	55.5
Lm 1	60.0
Lm 2	55.0
Ch 2	53.6
Lm 1	60.0
Lm 2	55.0

2.5. ADJUSTMENT OF THE HPM-RM1 UNIT

Push "DISPLAY LIMITS" on the HPM-RM1 unit and the DCU-display will indicate the measured value and the limit values. All indicated values are recalculated according to the programmed nominal A and B-chamber pressure. The nominal pressure is programmable in the DCU unit (see PRO-DD1 Programming manual).

2.5.1 MEASURED VALUE

"Ch A" indicates the measured value for the A-chamber pressure.

"Ch B" indicates the measured value for the B-chamber pressure.

2.5.2 ADJUST A-CHAMBER LIMIT 1

Read the value at "Ch A, Lm 1" and adjust the potentiometer "A-CHAMBER, LIMIT 1" to the desired value. Values can be adjusted between 0 and 100% of nominal A-chamber pressure.

2.5.3 ADJUST A-CHAMBER LIMIT 2

Read the value at "Ch A, Lm 2" and adjust the potentiometer "A-CHAMBER, LIMIT 2" to the desired value. Values can be adjusted between 0 and 100% of nominal A-chamber pressure.

2.5.4 ADJUST B-CHAMBER LIMIT 1

Read the value at "Ch B, Lm 1" and adjust the potentiometer "B-CHAMBER, LIMIT 3" to the desired value. Values can be adjusted between 0 and 100% of nominal B-chamber pressure.

2.5.5 ADJUST B-CHAMBER LIMIT 2

Read the value at "Ch B, Lm 2" and adjust the potentiometer "B-CHAMBER, LIMIT 4" to the desired value. Values can be adjusted between 0 and 100% of nominal B-chamber pressure.

DCA	2.23
DTM	168
POM	39.46
HPM	ton
Ch A	33.5
Lm 1	22.0
Lm 2	20.0
Ch B	15.6
Lm 1	14.5
Lm 2	13

2.6. ADJUSTMENT OF THE POM-RM1 UNIT

Push "DISPLAY LIMITS" on the POM-RM1 unit and the DCU-display will indicate the measured value and the limit values.

2.6.1 MEASURED VALUE

The measured value is indicated by "POM".

2.6.2 ADJUST LIMIT 1

Read the value at "Lm 1" and adjust the potentiometer "LIMIT 1" to the desired value. Values can be adjusted between 0 and 50.00 mm.

2.6.3 ADJUST LIMIT 2

Read the value at "Lm 2" and adjust the potentiometer "LIMIT 2" to the desired value. Values can be adjusted between 0 and 50.00 mm.

2.6.4 ADJUST LIMIT 3

Read the value at "Lm 3" and adjust the potentiometer "LIMIT 3" to the desired value. Values can be adjusted between 0 and 50.00 mm.

DCA	2.23
DTM	168
POM	39.46
POM	mm
Lm 1	42.0
Lm 2	10.0
Lm 3	4.5

2.7. ADJUSTMENT OF THE TVD-RM1 UNIT

Push "DISPLAY LIMITS" on the TVD-RM1 unit and the DCU-display will indicate the measured value and the limit values.

2.7.1 MEASURED VALUE

The measured value is indicated by "TVD".

2.7.2 ADJUST LIMIT 1

Read the value at "Lm 1" and adjust the potentiometer "LIMIT 1" to the desired value. Values can be adjusted between 0 and 100%.

2.7.3 ADJUST LIMIT 2

Read the value at "Lm 2" and adjust the potentiometer "LIMIT 2" to the desired value. Values can be adjusted between 0 and 100%.

DCA	2.23
DTM	168
POM	39.46
TVD	%
TVD	0.0
Lm 1	60.0
Lm 2	50.0

2.8. ADJUSTMENT OF THE DTM-RM1 UNIT

Push "DISPLAY LIMITS" on the DTM-RM1 unit and the DCU-display will indicate the measured value and the limit values.

2.8.1 MEASURED VALUE

The measured value is indicated by "DTM".

2.8.2 ADJUST LIMIT 1

Read the value at "Lm 1" and adjust the potentiometer "LIMIT 1" to the desired value. Values can be adjusted between 0 and 225 °C.

2.8.3 ADJUST LIMIT 2

Read the value at "Lm 2" and adjust the potentiometer "LIMIT 2" to the desired value. Values can be adjusted between 0 and 225 °C.

2.8.3 ADJUST LIMIT 3

Read the value at "Lm 3" and adjust the potentiometer "LIMIT 3" to the desired value. Values can be adjusted between 0 and 225 °C.

DCA	2.23
DTM	168
POM	39.46
DTM	°C
Lm 1	200
Lm 2	185
Lm 3	100

2.9. ADJUSTMENT OF THE DCA-RM1 UNIT

Push "DISPLAY LIMITS" on the DCA-RM1 unit and the DCU-display will indicate the measured and the limit values.

The DCA linear nominal range can be set to 2.00 mm.

2.9.1 MEASURED VALUE

The measured value is indicated by "DCA".

2.9.2 ADJUST LIMIT "+ +"

Read the value at "++" and adjust the potentiometer "+ +" to the desired value. Values can be adjusted between 0.00 and the nominal range.

2.9.3 ADJUST LIMIT "+"

Read the value at "+" and adjust the potentiometer "+" to the desired value. Values can be adjusted between 0.00 and the nominal range.

2.9.4 ADJUST LIMIT "-"

Read the value at "-" and adjust the potentiometer "-" to the desired value. Values can be adjusted between 0.00 and the nominal range.

2.9.5 ADJUST LIMIT "-L"

Read the value at "-L" and adjust the potentiometer "-L" to the desired value. Values can be adjusted between 0.00 and the nominal range.

2.9.6 ADJUST LIMIT "- -"

Read the value at "- -" and adjust the potentiometer "- -" to the desired value. Values can be adjusted between 0.00 and the nominal range.

2.9.7 HOW TO USE THE DCA ALARM LIMITS, DCA-RM1

The 4 separate limits can be adjusted between 0.00 - nominal range. These limits are constantly compared with the DCA-signal, displayed on the DCA panel meter.

These limits are most suitably used in accordance with the chart below.

At the time of delivery, the limits are adjusted as follows (with 2.00 mm range):

$$++ = 1.20, \quad + = 1.10, \quad - = 0.70, \quad - - = 0.20$$

DCA	2.23
DTM	168
POM	39.46
DCA	mm
Lm ++	1.20
Lm +	0.90
Lm -	0.70
Lm -L	0.50
Lm - -	0.20